

General Description

BDE-RFM207P is a multiprotocol 2.4G wireless module targeted at low power sensors and PC/Phone accessories. It supports Thread, Zigbee, Bluetooth 5.0 Low Energy, IEEE 802.15.4g, IPv6-enabled smart objects (6LoWPAN), Wi-SUN, proprietary systems, SimpleLink TI 15.4-Stack (2.4 GHz), and Dynamic Multiprotocol Manager (DMM) driver.



BDE-RFM207P has an integrated power amplifier, which enable 20 dBm output power.

BDE-RFM207P highly integrates radio, stack, profile and applications in a SoC, without the need of using an external MCU. The module also offers flexible hardware interfaces for the sensor application. It enables ultra-low power connectivity and data transfer for the applications that are sensitive to power consumption, size and cost.

Key Features

- Microcontroller
 - Powerful 48-MHz Arm® Cortex®-M4F processor
 - 352KB of in-system Programmable Flash
 - 256KB of ROM for protocols and library functions
 - 8KB of Cache SRAM (Alternatively available as general-purpose RAM)
 - 80KB of ultra-low leakage SRAM. The SRAM is protected by parity to ensure high reliability of operation.
 - 2-Pin cJTAG and JTAG debugging RF performance
 - Supports Over-the-Air upgrade (OTA)
- Ultra-low power sensor controller with 4KB of SRAM
 - Sample, store, and process sensor data
 - Operation independent from system CPU
 - Fast wake-up for low-power operation BQB, FCC, CE, RoHS compliant
- TI-RTOS, drivers, Bootloader, Bluetooth® 5 Low Energy Controller, and IEEE 802.15.4 MAC in ROM for optimized application size
- Peripherals
 - Digital peripherals can be routed to any GPIO
 - 4× 32-bit or 8× 16-bit general-purpose timers
 - 12-Bit ADC, 200 kSamples/s, 8 channels
 - 2× comparators with internal reference DAC
 - (1× continuous time, 1× ultra-low power)
 - Programmable current source
 - 2× UART
 - 2× SSI (SPI, MICROWIRE, TI)
 - I2C
 - I2S
 - Real-Time Clock (RTC)
 - AES 128- and 256-bit Crypto Accelerator
 - ECC and RSA Public Key Hardware Accelerator
 - SHA2 Accelerator (Full suite up to SHA-512)
 - True Random Number Generator (TRNG)

- Capacitive sensing, up to 8 channels
- Integrated temperature and battery monitor
- External system
 - On-chip Buck DC/DC converter
- Low power
 - Wide supply voltage range: 1.8 V to 3.8 V
 - Active-Mode RX: 6.9 mA
 - Active-Mode TX 0 dBm: 7.3 mA
 - Active-Mode TX 5 dBm: 9.6 mA
 - Active-Mode TX at +10 dBm: 22 mA
 - Active-Mode TX at +20 dBm: 85 mA
 - Active-Mode MCU 48 MHz (CoreMark):
 - 3.4 mA (71 μ A/MHz)
 - Sensor Controller, Low Power-Mode, 2 MHz, running infinite loop: 30.1 μ A
 - Sensor Controller, Active-Mode, 24 MHz, running infinite loop: 808 μ A
 - Standby: 0.94 μ A (RTC on, 80KB RAM and CPU retention)
 - Shutdown: 150 nA (wakeup on external events)
- Radio section
 - 2.4 GHz RF transceiver compatible with Bluetooth 5.0 Low Energy compliant and IEEE 802.15.4 PHY and MAC
 - Excellent receiver sensitivity:
 - 100 dBm for 802.15.4 (2.4 GHz),
 - -105 dBm for Bluetooth 125-kbps (LE Coded PHY)
 - Output power up to +20 dBm with temperature compensation
 - Suitable for systems targeting compliance with worldwide radio frequency regulations
- Wireless protocols
 - Thread, Zigbee®, Bluetooth® 5 Low Energy, IEEE 802.15.4g, IPv6-enabled smart objects (6LoWPAN), Wi-SUN®, proprietary systems, SimpleLink™ TI 15.4-Stack (2.4 GHz), and Dynamic Multiprotocol Manager (DMM) driver.
- Size: 29.86 mm x 19.98 mm x 2.15 mm (With Shielding)
- Certification
 - FCC ID: 2ABRU-RFM207P
 - IC: 25657-RFM207P
 - CE-RED

Applications

- 2400 to 2480 MHz ISM and SRD systems with down to 4 kHz of receive bandwidth
- Building automation
- Grid infrastructure
- Industrial transport – asset tracking
- Factory automation and control
- Medical
- Electronic point of sale (EPOS) – Electronic Shelf Label (ESL)

Contents

General Description	1
Key Features	1
Applications.....	3
Contents.....	4
1. References.....	5
2. Block Diagram.....	6
3. Terminal Configuration and Functions	7
3.1 Pin Diagram.....	7
3.2 Pin Attributes and Pin Multiplexing.....	7
4. Specifications	9
4.1 Absolute Maximum Ratings.....	9
4.2 Recommended Operating Conditions	9
5. Reference Design	10
5.1 Design Recommendations	10
6. Typical Solder Reflow Profile	12
7. Mechanical Specifications.....	13
7.1 Dimensions.....	13
8. Packaging Information	14
9. Ordering Information	15
10. Revision History.....	15

1. References

[1] CC2652P resources: <https://www.ti.com/product/CC2652>

2. Block Diagram

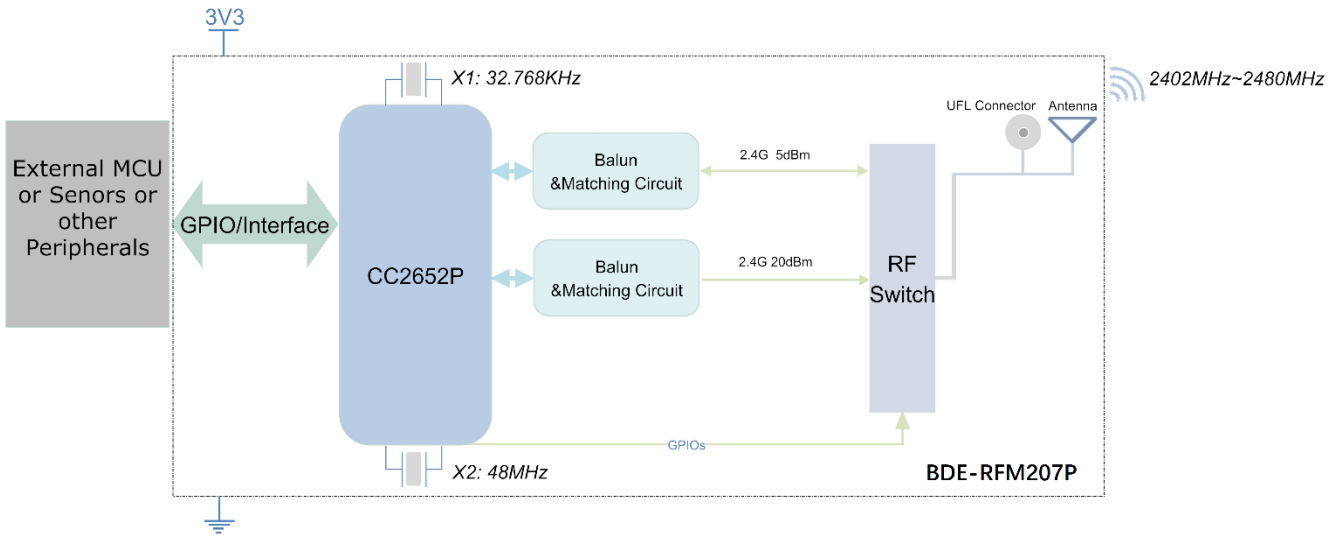

Figure 2-1. BDE-RFM207P Module Block Diagram

3. Terminal Configuration and Functions

3.1 Pin Diagram

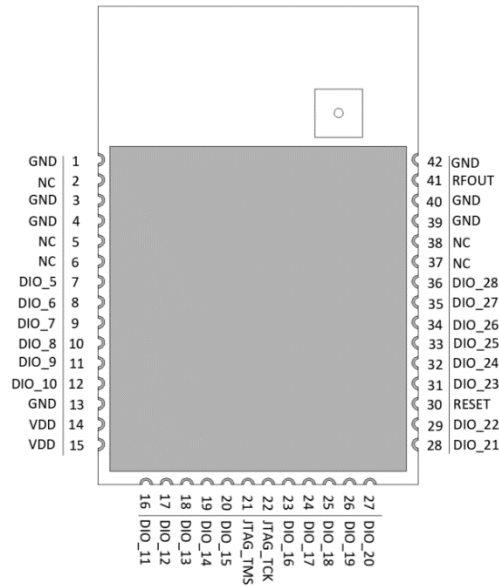

Figure 3-1. Pin Diagram (Top View)

3.2 Pin Attributes and Pin Multiplexing

Table 3-1. Pin Description

Pin #	Pin Name	Description
1	GND	Power Ground
2	NC	NC
3	GND	Power Ground
4	GND	Power Ground
5	NC	NC
6	NC	NC
7	DIO_5	GPIO, High-drive Capability
8	DIO_6	GPIO, High-drive Capability
9	DIO_7	GPIO, High-drive Capability
10	DIO_8	GPIO
11	DIO_9	GPIO
12	DIO_10	GPIO
13	GND	Power Ground
14	VDD	Supply Power
15	VDD	Supply Power
16	DIO_11	GPIO
17	DIO_12	GPIO
18	DIO_13	GPIO
19	DIO_14	GPIO
20	DIO_15	GPIO
21	JTAG_TMSC	JTAG TMS, High-drive Capability

Pin #	Pin Name	Description
22	JTAG_TCKC	JTAG TCKC
23	DIO_16	GPIO, JTAG_TDO, High-drive Capability
24	DIO_17	GPIO, JTAG_TDI, High-drive Capability
25	DIO_18	GPIO
26	DIO_19	GPIO
27	DIO_20	GPIO
28	DIO_21	GPIO
29	DIO_22	GPIO
30	RESET	Reset, Active Low
31	DIO_23	GPIO, Analog Capability
32	DIO_24	GPIO, Analog Capability
33	DIO_25	GPIO, Analog Capability
34	DIO_26	GPIO, Analog Capability
35	DIO_27	GPIO, Analog Capability
36	DIO_28	GPIO, Analog Capability
37	NC	NC
38	NC	NC
39	GND	Power Ground
40	GND	Power Ground
41	RFOUT	2.4G RF Output Port
42	GND	Power Ground

4. Specifications

4.1 Absolute Maximum Ratings

PARAMETER	MIN	MAX	UNIT	Notes
VDDS	-0.3	4.1	V	
Other Digital Terminals	-0.3	$V_{DD5}+0.3 \leq 4.1$	V	
Voltage on ADC input	-0.3	VDDS	V	Voltage scaling enabled
	-0.3	1.49	V	Voltage scaling disabled, internal reference
	-0.3	$V_{DD5}/2.9$	V	Voltage scaling disabled, VDDS as reference
RF pin	-	2	dBm	
Storage Temperature	-40	125	°C	

4.2 Recommended Operating Conditions

PARAMETER	MIN	TYP	MAX	UNIT
VDDS	2.1	3.3	3.8	V
Operating Temperature	-40	-	85	°C

5. Reference Design

5.1 Design Recommendations

In order to get a fine performance when integrate the module to your product, it is advised to use the recommended module location to the respective PCB.

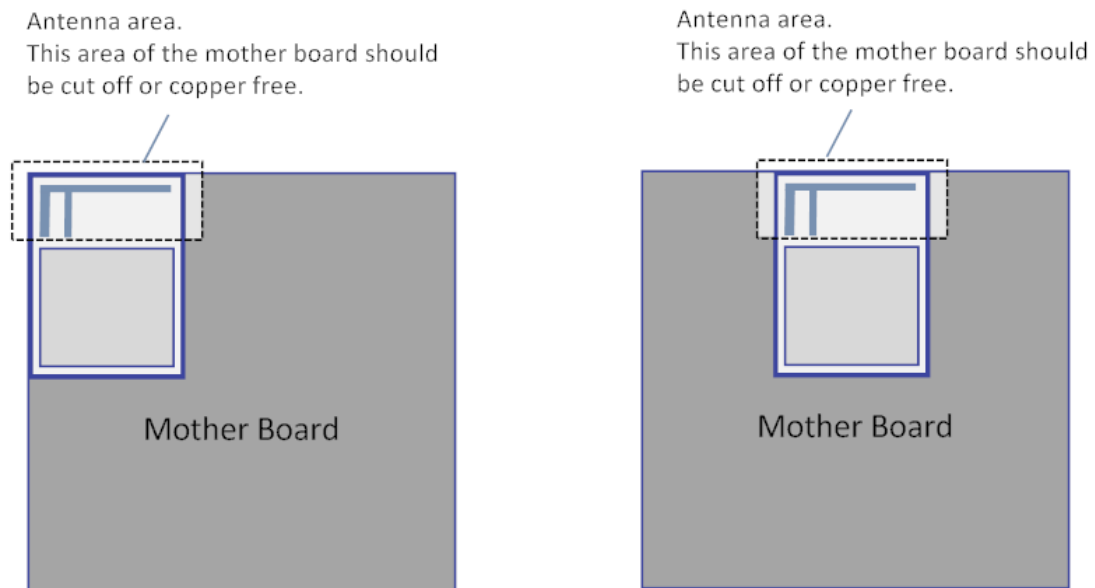

■ Location in X-Y plane

Figure 5-1. Recommended location in X-Y plane

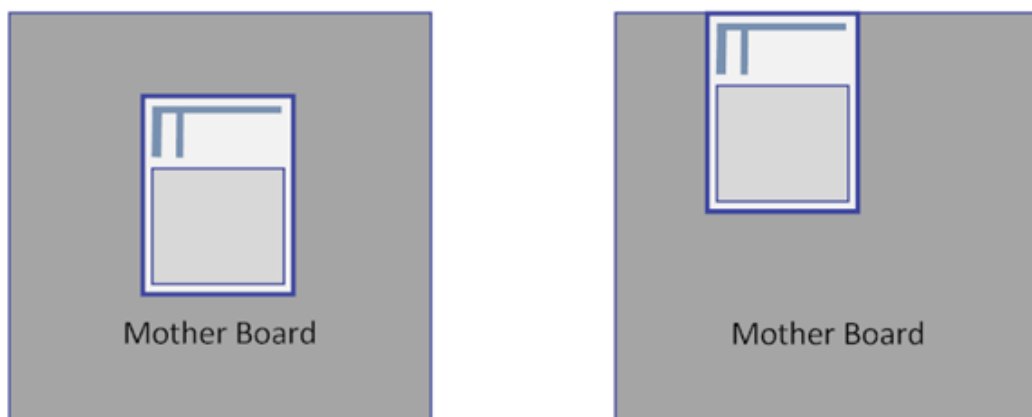

Figure 5-2. Not recommended location in X-Y plane

■ Location in Z plane

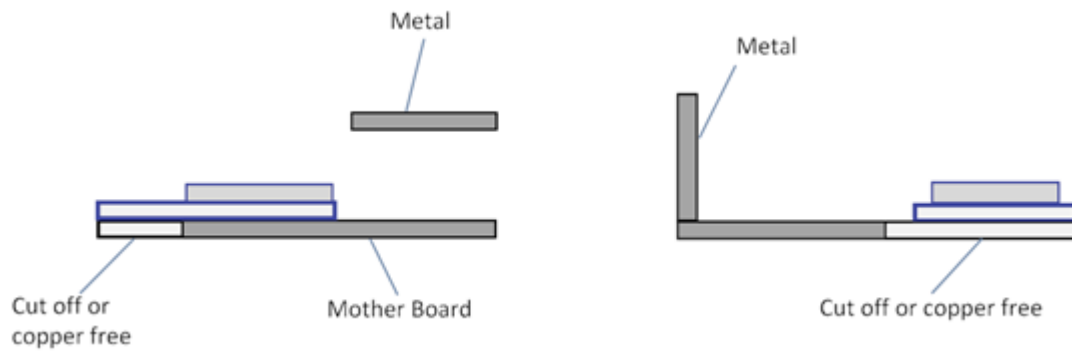

Figure 5-3. Recommended location in Z plane



Figure 5-4. Not recommended location in Z plane

6. Typical Solder Reflow Profile

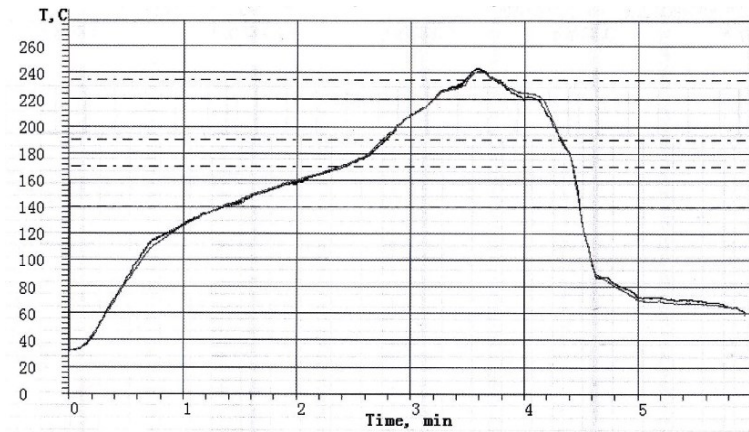

Figure 6-1. Typical Solder Reflow Profile

7. Mechanical Specifications

7.1 Dimensions

Fig 7-1 shows the overall dimensions of BDE-RFM207P. The module measures 22.95mm long by 15mm wide by 2.15mm high with the shield.

Note: All dimensions are in mm.

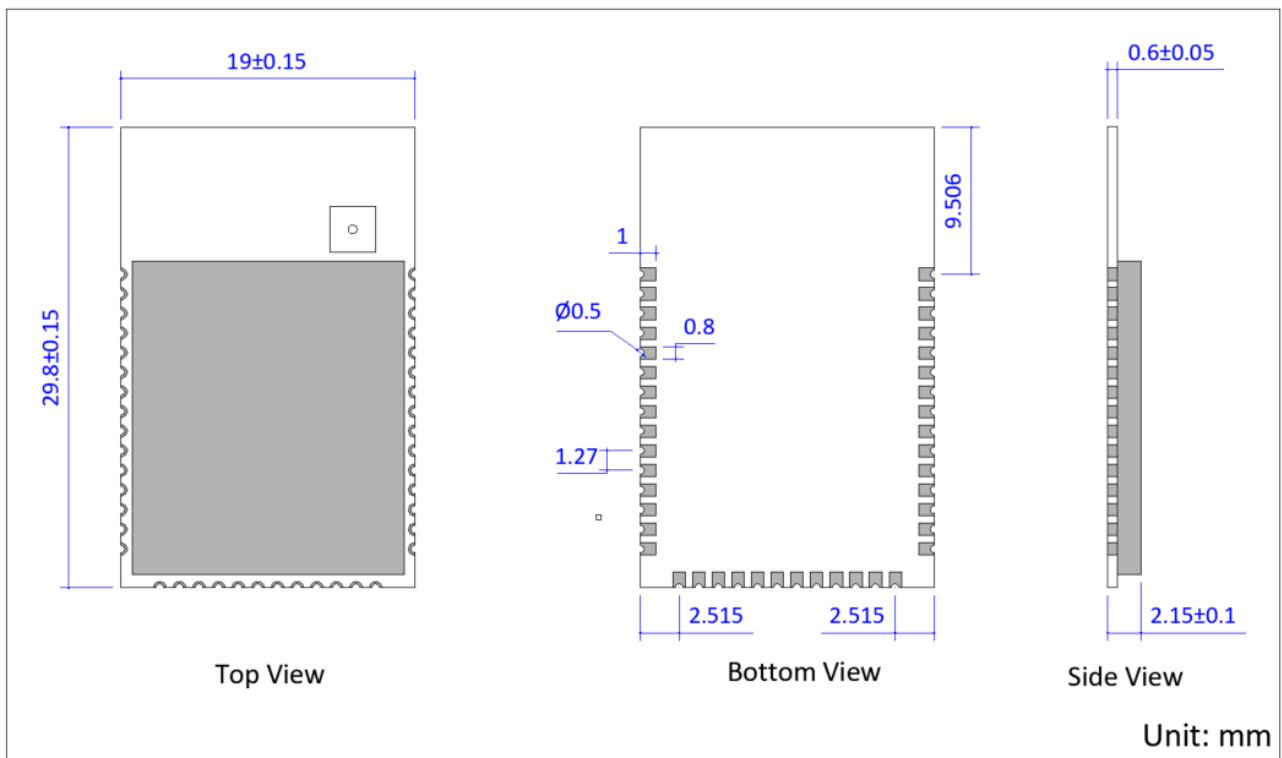

Figure 7-1. Mechanical Drawing

8. Packaging Information



Figure 8-1. Package

9. Ordering Information

Part Number	Size (mm)	Core Chip	Shipping Form	MOQ
BDE-RFM207P	29.8 x 19 x 2.15	CC2652P	Tray	1K

10. Revision History

Revision	Date	Description
V1.0	8-Jul-2019	Initial Release
V1.1	20-Jul-2019	Editorial Correction
V2.0	14-Apr-2021	Replacement of template
V2.1	23-Apr-2022	Correct some mistakes

Contacts

BDE Technology Inc.

China: B2-403, 162 Science Avenue, Huangpu District, Guangzhou 510663, China

Tel: +86-20-28065335

Website: <http://www.bdecomm.com>

Email: shu@bdecomm.com

USA: 67 E Madison St, # 1603A, Chicago, IL 60603, US

Tel: +1-312-379-9589

Website: <http://www.bdecomm.com>

Email: info@bdecomm.com